

MAȘINI ȘI ECHIPAMENTE - CATALOG GENERAL

DETOOLZ

SMART WORK



01	Pompe apă menajeră cu și fără tocător	pag. 5	cod 0106
02	Pompe de stropit cu acumulator	pag. 8	cod 010901
03	Pompe de stropit manuale	pag. 10	cod 010902
04	Compresiune pentru alimentare apă și irigații	pag. 11	cod 010908
05	Fierăstraie electrice cu lanț	pag. 17	cod 0402
06	Trimere electrice	pag. 18	cod 0504
07	Foarfeci electrice cu acumulatori	pag. 19	cod 0601
08	Mașini de tocat carne electrice	pag. 20	cod 080101
09	Mașini de măturat manuale	pag. 21	cod 081101
10	Invertoare / Aparate de sudură	pag. 22	cod 090101
11	Echipamente instalator	pag. 23	cod 090304
12	Fierăstraie electrice circulare	pag. 25	cod 09040101
13	Fierăstraie circulare staționare	pag. 26	cod 09040102
14	Fierăstraie electrice pendulare	pag. 27	cod 09040202
15	Scule pneumatice	pag. 29	cod 090202
16	Mixere mortar sau vopsea	pag. 30	cod 0908
17	Șlefuitoare electrice cu aspirator	pag. 32	cod 090501
18	Șlefuitoare beton umed	pag. 35	cod 090503
19	Mașini electrice tăiat caneluri	pag. 35	cod 090305
20	Mașini de găurit și înșurubat cu acumulatori	pag. 37	cod 090601
21	Ciocane rotopercutoare cu acumulator	pag. 42	cod 090604
22	Fierăstraie pendulare cu acumulator	pag. 42	cod 09040203
23	Polizoare unghiulare cu acumulatori	pag. 43	cod 09070203
24	Mașini de găurit și înșurubat electrice	pag. 44	cod 090602
25	Ciocane rotopercutoare	pag. 46	cod 090603
26	Polizoare unghiulare	pag. 48	cod 09070201
27	Telemetre	pag. 50	cod 091301
28	Mașini de tăiat plăci ceramice	pag. 51	cod 09140102
29	Mașini de tăiat parchet	pag. 54	cod 09140101
30	Patenți și clești	pag. 54	cod 091403
31	Ciocane manuale	pag. 54	cod 091407

Pompe apă menajeră

pag. 5



0106

Pompe de stropit cu acumulator

pag. 8



010901

Pompe de stropit manuale

pag. 10



010902

Compresione

pag. 11



010908

Fierăstraie electrice

pag. 17



0402

Mașini de măturat manuale

pag. 21



081101

Trimmere electrice

pag. 18



0504

Foarfecă cu acumulator

pag. 19



0601

Aparate de sudură

pag. 22



090101

Echipamente instalator

pag. 23



090304

Mașină de tocat carne

pag. 20



080101

Fierăstraie circulare

pag. 25



09040101

Fierăstraie pendulare

pag. 27



09040202

Fierăstraie staționare pag. 26



Scule pneumatice pag. 29



Mixere mortar și vopsea pag. 30



Șlefuitoare electrice cu aspirator pag. 32



Mașini de găurit și înșurubat cu acumulatori pag. 37



Șlefuitor beton umed pag. 35



Mașini tăiat caneluri pag. 35



Ciocane rotopercutoare
cu acumulator pag. 42



Fierăstrăie pendulare
cu acumulator pag. 42



Polizoare unghiulare
cu acumulator pag. 43



Telemetre pag. 50



Mașini de tăiat
plăci ceramice pag. 51



Mașină de tăiat parchet pag. 54



Mașini de găurit și înșurubat
electrice pag. 44



Ciocane rotopercutoare pag. 46



Polizoare unghiulare pag. 48



Patenți și clești pag. 54



Ciocane manuale pag. 54



POMPĂ SUBMERSIBILĂ PENTRU APĂ CURATĂ / MURDARĂ 3 în 1 • 400W

DZ-P100



ACCESORII INCLUSE:

Grătar aspirație nivel mediu, grătar aspirație nivel mare, plutitor întrerupător

SPECIFICAȚII TEHNICE

Tensiune/Frecvență	220-230V/50Hz
Putere (kW/CP)	0,4 kW / 0,54 CP
Adâncime submersie	7 m
Înălțime refluxare	13 m
Debit	11 m ³ /h
Diametru conexiune	1" -1.1/4"



1 bucată / cutie
4 bucăți / bax
Cod bare: 6426910014267

POMPĂ SUBMERSIBILĂ PENTRU APĂ CURATĂ / MURDARĂ 3 în 1 • 500W

DZ-P101



ACCESORII INCLUSE:

Grătar aspirație nivel mediu, grătar aspirație nivel mare, plutitor întrerupător

SPECIFICAȚII TEHNICE

Tensiune/Frecvență	220-230V/50Hz
Putere (kW/CP)	0,5 kW / 0,70 CP
Adâncime submersie	7 m
Înălțime refluxare	14 m
Debit	12,5 m ³ /h
Diametru conexiune	1" -1.1/4"



1 bucată / cutie
4 bucăți / bax
Cod bare: 6426910014274

POMPĂ SUBMERSIBILĂ PENTRU APĂ CURATĂ / MURDARĂ 3 în 1 • 750W

DZ-P102



ACCESORII INCLUSE:

Grătar aspirație nivel mediu, grătar aspirație nivel mare, plutitor întrerupător

SPECIFICAȚII TEHNICE

Tensiune/Frecvență	220-230V/50Hz
Putere (kW/CP)	0,75 kW / 1 CP
Adâncime submersie	7 m
Înălțime refluxare	15,5 m
Debit	17,5 m ³ /h
Diametru conexiune	1" -1.1/4"



1 bucată / cutie

4 bucăți / bax

Cod bare: 6426910014281

Pompă apă submersibilă WQD1500DF cu tocător • 1.500W

DZ-P107



ACCESORII INCLUSE:

Tocător interior, picioare înălțătoare, plutitor întrerupător

SPECIFICAȚII TEHNICE

Tensiune/Frecvență	220-230V/50Hz
Putere (kW/CP)	1,5 kW / 2 CP
Adâncime submersie	7 m
Înălțime refluxare	21 m
Debit	23 m ³ /h
Diametru conexiune	2"



1 bucată / cutie

1 bucată / bax

Cod bare: 6426910015127

POMPĂ DE STROPIT CU ACUMULATOR 5L DZ

DZ-P108



Compactă, fiabilă, versatilă, ușoară - poate fi utilizată fără efort

ACCESORII INCLUSE:

Lance CF-35B, Furtun presiune mare

SPECIFICAȚII TEHNICE

Volum	5 L
Tip	Acumulator
Tip acumulator	Li-Ion
Culoare	Verde Detoolz



1 bucată / cutie

6 bucăți / bax

Cod bare: 6426910019248

POMPĂ DE STROPIT CU ACUMULATOR • 16L • FURTUN PRESIUNE DZ

DZ-P110

Ham de susținere confortabil, ușor de utilizat

ACCESORII INCLUSE:

Lance CF-35B, Furtun presiune mare

SPECIFICAȚII TEHNICE

Volum	16 L
Tip	Acumulator
Tip acumulator	Li-Ion 9Ah
Culoare	Alb / Verde Detoolz

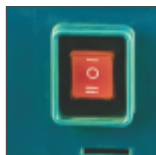

1 bucată / cutie

3 bucăți / bax

Cod bare: 6426910019262

POMPĂ DE STROPIT CU ACUMULATOR • 16L • SUPORT LOMBAR

DZ-P109



SUPOORT LOMBAR



ACCESORII INCLUSE:

Lance CF-35B, Furtun presiune mare

SPECIFICAȚII TEHNICE

Volum	16 L
Tip	Acumulator
Tip acumulator	Li-Ion 9Ah
Culoare	Verde Detoolz

Ham de susținere confortabil, suport lombar,
ușor de folosit perioade lungi de timp



1 bucată / cutie
3 bucăți / bax

Cod bare: 6426910019255

POMPĂ DE STROPIT MANUALĂ • 2L DE PRESIUNE MARE DZ

DZ-P111



ACCESORII INCLUSE:

Elemente de presiune mare

SPECIFICAȚII TEHNICE

Volum	2 L
Tip	Manuală
Culoare	Transparent/Verde Detoolz



1 bucată / cutie
20 bucăți / bax
Cod bare: 6426910019279

POMPĂ DE STROPIT MANUALĂ • 2L DZ

DZ-P112



SPECIFICAȚII TEHNICE

Volum	2 L
Tip	Manuală
Culoare	Verde Detoolz



1 bucată / cutie
20 bucăți / bax
Cod bare: 6426910019286

COMPRESIUNE PENTRU ALIMENTARE APĂ ȘI IRIGAȚII (COD 010908)

MUFE COMPRESIUNE EGALE PN16

- Material: Polipropilenă
- Utilizare: Tubulatură din polietilenă de înaltă densitate (PEHD/PE)

Cod produs	Diametru conexiune țevă	Presiune nominală	Nr. Buc pungă/bax	Cod bare
DZ-CO100	Ø20 mm	PN16	20/280	6426910019767
DZ-CO101	Ø25 mm	PN16	10/160	6426910019774
DZ-CO102	Ø32 mm	PN16	10/100	6426910019781
DZ-CO103	Ø40 mm	PN16	5/60	6426910019798



MUFE COMPRESIUNE REDUSE PN16

- Material: Polipropilenă
- Utilizare: Tubulatură din polietilenă de înaltă densitate (PEHD/PE)

Cod produs	Diametru conexiune țevă	Presiune nominală	Nr. Buc pungă/bax	Cod bare
DZ-CO104	Ø25 - Ø20 mm	PN16	10/220	6426910019804
DZ-CO105	Ø32 - Ø25 mm	PN16	10/120	6426910019811
DZ-CO106	Ø40 - Ø32 mm	PN16	6/60	6426910019828



RACORD COMPRESIUNE CU FILET INTERIOR PN16

- Material: Polipropilenă
- Utilizare: Tubulatură din polietilenă de înaltă densitate (PEHD/PE)

Cod produs	Diametru conexiune țevă	Diametru conexiune filet	Presiune nominală	Nr. Buc pungă/bax	Cod bare
DZ-CO111	Ø20 mm	1/2"	PN16	20/480	6426910019873
DZ-CO112	Ø25 mm	3/4"	PN16	20/300	6426910019880
DZ-CO113	Ø32 mm	1"	PN16	10/160	6426910019897
DZ-CO114	Ø40 mm	1.1/4"	PN16	5/100	6426910019903



RACORD COMPRESIUNE CU FILET EXTERIOR PN16

- Material: Polipropilenă
- Utilizare: Tubulatură din polietilenă de înaltă densitate (PEHD/PE)

Cod produs	Diametru conexiune țevă	Diametru conexiune filet	Presiune nominală	Nr. Buc pungă/bax	Cod bare
DZ-CO107	Ø20 mm	1/2"	PN16	20/480	6426910019835
DZ-CO108	Ø25 mm	3/4"	PN16	20/300	6426910019842
DZ-CO146	Ø25 mm	1"	PN16	20/300	6426910020220
DZ-CO147	Ø32 mm	3/4"	PN16	10/180	6426910020237
DZ-CO109	Ø32 mm	1"	PN16	10/180	6426910019859
DZ-CO110	Ø40 mm	1.1/4"	PN16	5/100	6426910019866



COT COMPRESIUNE EGAL PN16

- Material: Polipropilenă
- Utilizare: Tubulatură din polietilenă de înaltă densitate (PEHD/PE)

Cod produs	Diametru conexiune țevă	Presiune nominală	Nr. Buc pungă/bax	Cod bare
DZ-CO115	Ø20 mm	PN16	20/280	6426910019910
DZ-CO116	Ø25 mm	PN16	20/160	6426910019927
DZ-CO117	Ø32 mm	PN16	10/100	6426910019934
DZ-CO118	Ø40 mm	PN16	5/50	6426910019941



COT COMPRESIUNE REDUS PN16

- Material: Polipropilenă
- Utilizare: Tubulatură din polietilenă de înaltă densitate (PEHD/PE)

Cod produs	Diametru conexiune țevă	Presiune nominală	Nr. Buc pungă/bax	Cod bare
DZ-CO119	Ø25 mm	PN16	10/120	6426910019958



COT COMPRESIUNE CU FILET EXTERIOR PN16

- Material: Polipropilenă
- Utilizare: Tubulatură din polietilenă de înaltă densitate (PEHD/PE)

Cod produs	Diametru conexiune țevă	Diametru conexiune filet	Presiune nominală	Nr. Buc pungă/bax	Cod bare
DZ-CO120	Ø20 mm	1/2"	PN16	20/400	6426910019965
DZ-CO121	Ø25 mm	3/4"	PN16	10/240	6426910019972
DZ-CO122	Ø32 mm	1"	PN16	10/140	6426910019989
DZ-CO123	Ø40 mm	1.1/4"	PN16	5/80	6426910019996



COT COMPRESIUNE CU FILET INTERIOR PN16

- Material: Polipropilenă
- Utilizare: Tubulatură din polietilenă de înaltă densitate (PEHD/PE)

Cod produs	Diametru conexiune țevă	Diametru conexiune filet	Presiune nominală	Nr. Buc pungă/bax	Cod bare
DZ-CO124	Ø20 mm	1/2"	PN16	20/360	6426910020008
DZ-CO125	Ø25 mm	3/4"	PN16	10/220	6426910020015
DZ-CO126	Ø32 mm	1"	PN16	10/140	6426910020022
DZ-CO127	Ø40 mm	1.1/4"	PN16	5/80	6426910020039



TEU COMPRESIUNE EGAL PN16

- Material: Polipropilenă
- Utilizare: Tubulatură din polietilenă de înaltă densitate (PEHD/PE)

Cod produs	Diametru conexiune țevă	Presiune nominală	Nr. Buc pungă/bax	Cod bare
DZ-CO128	Ø20 mm	PN16	10/160	6426910020046
DZ-CO129	Ø25 mm	PN16	10/80	6426910020053
DZ-CO130	Ø32 mm	PN16	5/50	6426910020060
DZ-CO131	Ø40 mm	PN16	5/30	6426910020077



TEU COMPRESIUNE REDUS PN16

- Material: Polipropilenă
- Utilizare: Tubulatură din polietilenă de înaltă densitate (PEHD/PE)

Cod produs	Diametru conexiune țevă	Presiune nominală	Nr. Buc pungă/bax	Cod bare
DZ-CO132	Ø25-Ø20-Ø25 mm	PN16	10/60	6426910020084
DZ-CO133	Ø32-Ø25-Ø32 mm	PN16	10/60	6426910020091
DZ-CO134	Ø40-Ø32-Ø40 mm	PN16	5/40	6426910020107



TEU COMPRESIUNE CU FILET EXTERIOR PN16

- Material: Polipropilenă
- Utilizare: Tubulatură din polietilenă de înaltă densitate (PEHD/PE)

Cod produs	Diametru conexiune țevă	Diametru conexiune filet	Presiune nominală	Nr. Buc pungă/bax	Cod bare
DZ-CO135	Ø20 mm	1/2"	PN16	20/200	6426910020114
DZ-CO136	Ø25 mm	3/4"	PN16	10/120	6426910020121
DZ-CO137	Ø32 mm	1"	PN16	10/70	6426910020138
DZ-CO138	Ø40 mm	1.1/4"	PN16	5/40	6426910020145



TEU COMPRESIUNE CU FILET INTERIOR PN16

- Material: Polipropilenă
- Utilizare: Tubulatură din polietilenă de înaltă densitate (PEHD/PE)

Cod produs	Diametru conexiune țevă	Diametru conexiune filet	Presiune nominală	Nr. Buc pungă/bax	Cod bare
DZ-CO139	Ø20 mm	1/2"	PN16	20/200	6426910020152
DZ-CO140	Ø25 mm	3/4"	PN16	10/120	6426910020169
DZ-CO141	Ø32 mm	1"	PN16	10/60	6426910020176
DZ-CO142	Ø40 mm	1.1/4"	PN16	5/40	6426910020183

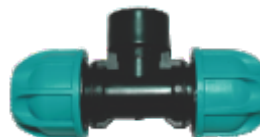

DOP COMPRESIUNE PN16

- Material: Polipropilenă
- Utilizare: Tubulatură din polietilenă de înaltă densitate (PEHD/PE)

Cod produs	Diametru conexiune țevă	Presiune nominală	Nr. Buc pungă/bax	Cod bare
DZ-CO143	Ø20 mm	PN16	20/560	6426910020190
DZ-CO144	Ø25 mm	PN16	20/360	6426910020206
DZ-CO145	Ø32 mm	PN16	10/200	6426910020213
DZ-C149	Ø40 mm	PN16		6426910020244



FIERĂSTRĂU ELECTRIC CU LANȚ 2.400W 101D

DZ-D101



SPECIFICAȚII TEHNICE

Tensiune/Frecvență	220-230V/50Hz
Putere	2.400 W / 3,22 CP
Lungime lamă/șină	40 cm
Pas lanț	3/8" LP
Nr. piteni / Nr. dinți	57 / 28,5



1 bucată / cutie
2 bucăți / bax
Cod bare: 6426910015134

FIERĂSTRĂU ELECTRIC CU LANȚ 2.400W 151D

DZ-D102



SPECIFICAȚII TEHNICE

Tensiune/Frecvență	220-230V/50Hz
Putere	2.000 W / 2,68 CP
Lungime lamă/șină	40 cm
Pas lanț	3/8" LP
Nr. piteni / Nr. dinți	57 / 28,5



1 bucată / cutie
2 bucăți / bax
Cod bare: 6426910015141

FIERĂSTRĂU ELECTRIC CU LANȚ 1.600W 153D

DZ-D103



SPECIFICAȚII TEHNICE

Tensiune/Frecvență	220-230V/50Hz
Putere	1.600 W / 2,15 CP
Lungime lamă/șină	40 cm
Pas lanț	3/8" LP
Nr. pînteni / Nr. dinți	57 / 28,5



1 bucată / cutie
2 bucăți / bax
Cod bare: 6426910015158

LANȚURI PENTRU DRUJBE / FIERĂSTRAIE ELECTRICE (COD 040303)

Cod produs	Descriere produs	Număr dinți / pînteni	Pas lanț	Lungime șină	Nr. Buc cutie/bax	Cod bare
DZ-D104	Lanț drujbă	25/50	3/8" LP	35 cm	1/50	6426910017282
DZ-D105	Lanț drujbă	32/64	0,325"	40 cm	1/50	6426910017299
DZ-D106	Lanț drujbă	32/64	0,325"	40 cm	1/50	6426910019088
DZ-D107	Lanț drujbă	25/50	3/8" LP	35 cm	1/50	6426910019095



TRIMMER ELECTRIC PENTRU GRADINĂ 250W

DZ-SE124



SPECIFICAȚII TEHNICE

Tensiune/Frecvență	220-230V/50Hz
Putere	250W
Diametru tăiere	220 mm
Viteză de rotație	12.500 rpm
Diametru fir tăiere	1,2 mm



1 bucată / cutie
12 bucăți / bax
Cod bare: 6426910016308

TRIMMER ELECTRIC CU MÂNER TELESCOPIC 350W

DZ-SE125



SPECIFICAȚII TEHNICE

Tensiune/Frecvență	220-230V/50Hz
Putere	350W
Diametru tăiere	250 mm
Viteză de rotație	12.000 rpm
Diametru fir tăiere	1,2 mm



1 bucată / cutie
8 bucăți / bax
Cod bare: 6426910016315

FOARFECĂ CU ACUMULATOR 3,6V PENTRU TUNS GAZON/GARD VIU

DZ-SE126



SPECIFICAȚII TEHNICE

Tip acumulator	1,3 Ah
Tensiune acumulator	3,6 V
Durată minimă de funcționare	40 min
Lungime cuțit foarfec iarbă	80 mm
Lungime cuțit foarfec tufe	120 mm
Gosime tăiere foarfec tufe	7 mm
Rotații pe minut	1.400 rpm



1 bucată / cutie

1 bucată / bax

Cod bare: 6426910016322



MAȘINĂ ELECTRICĂ DE TOCAT CARNE 1.400W

DZ-CB100

ACCESORII INCLUSE:

Accesoriu cârnați, accesoriu kibbe, accesorii roșii

SPECIFICAȚII TEHNICE

Tensiune/Frecvență	220-230V/50Hz
Putere	1.400 W
Culoare	Verde Detoolz



1 bucată / cutie

4 bucăți / bax

Cod bare: 6426910014335



MAȘINĂ DE MĂTURAT MANUALĂ 700 mm 14L MS70

DZ-CI100



SPECIFICAȚII TEHNICE

Mod acționare	Manual
Lățime de acționare	700 mm
Capacitate rezervor	14 L
Suprafață maximă măturare	2.800 m ² /h
Viteză maximă deplasare	4 km/h



1 bucată / cutie
1 bucată / bax
Cod bare: 6426910019163

MAȘINĂ DE MĂTURAT MANUALĂ 800 mm 30L MS80-A

DZ-CI101



SPECIFICAȚII TEHNICE

Mod acționare	Manual
Lățime de acționare	800 mm
Capacitate rezervor	30 L
Suprafață maximă măturare	3.200 m ² /h
Viteză maximă deplasare	4 km/h



1 bucată / cutie
1 bucată / bax
Cod bare: 6426910019170

APARAT DE SUDURĂ SEMI PROFESIONAL MMA

DZ-ES001



SPECIFICAȚII TEHNICE

Tensiune/Frecvență	220V/50Hz
Afișaj	Electronic
Tip electrod	1,6-5
Tip	Full bridge
Răcire	Ventilator
Funcție anti stick	Da
Cabluri	200A



1 bucată / cutie
4 bucăți / bax
Cod bare: 6426910015424

APARAT DE SUDURĂ SUPER POWER MMA

DZ-ES002

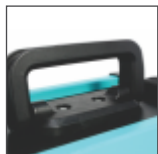

SPECIFICAȚII TEHNICE

Tensiune/Frecvență	220V/50Hz
Afișaj	Electronic
Tip electrod	1,6-5
Tip	Full bridge
Răcire	Ventilator
Funcție anti stick	Da
Cabluri	300A



1 bucată / cutie
1 bucată / bax
Cod bare: 6426910015561

TRUSĂ PENTRU SUDAT ȚEVI PPR 1.500W

DZ-EI100



ACCESORII INCLUSE:

Clește tăiat țevi, nivelă, șurubelniță, ruletă, inbus, mănuși, suport lucru

SPECIFICAȚII TEHNICE

Tensiune/Frecvență	220-230V/50Hz
Putere	1.500W
Bacuri incluse	20-63 mm
Capacitate de lucru	20-63 mm
Temp. suprafeței adaptoarelor	0-300°C
Timp încălzire	<15 min



1 bucată / cutie
5 bucăți / bax
Cod bare: 6426910016339

TRUSĂ PENTRU SUDAT ȚEVI PPR 600W

DZ-EI101



ACCESORII INCLUSE:

Inbus, mănuși, suport lucru

SPECIFICAȚII TEHNICE

Tensiune/Frecvență	220-230V/50Hz
Putere	600W
Bacuri incluse	20-63 mm
Capacitate de lucru	20-63 mm
Temp. suprafeței adaptoarelor	0-300°C
Timp încălzire	<15 min



1 bucată / cutie
10 bucăți / bax
Cod bare: 6426910016346

TRUSĂ PENTRU SUDAT ȚEVI PPR 900W

DZ-EI102



ACCESORII INCLUSE:

Șurubelniță, ruletă, inbus, mănuși, suport lucru

SPECIFICAȚII TEHNICE

Tensiune/Frecvență	220-230V/50Hz
Putere	900W
Bacuri incluse	20-63 mm
Capacitate de lucru	20-63 mm
Temp. suprafeței adaptoarelor	0-300°C
Timp încălzire	<15 min



1 bucată / cutie

5 bucăți / bax

Cod bare: 6426910016353

FOARFECĂ TĂIAT ȚEVI PVC 32 mm

DZ-EI103



SPECIFICAȚII TEHNICE

Capacitate de lucru	32 mm
---------------------	-------



6 bucăți / cutie

60 bucăți / bax

Cod bare: 6426910016360

FIERĂSTRĂU CIRCULAR ELECTRIC 1.200W 185 mm

DZ-SE100



SPECIFICAȚII TEHNICE

Tensiune/Frecvență	220V/50Hz
Putere	1.200W
Diametru disc	Ø185 mm / 24T
Viteză de rotație	5.800 rpm
Adâncime tăiere	0-62 mm
Ghidaj	Tijă



1 bucată / cutie
4 bucăți / bax
Cod bare: 6426910015172

FIERĂSTRĂU CIRCULAR ELECTRIC 480W 85 mm

DZ-SE101



SPECIFICAȚII TEHNICE

Tensiune/Frecvență	220V/50Hz
Putere	480W
Diametru disc	Ø85 mm
Viteză de rotație	3.500 rpm
Adâncime tăiere	0-27 mm
Ghidaj	Laser + Tijă



1 bucată / cutie
6 bucăți / bax
Cod bare: 6426910015189

FIERĂSTRĂU CIRCULAR STAȚIONAR 1.400W 210 mm

DZ-SE106

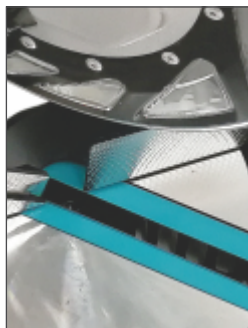
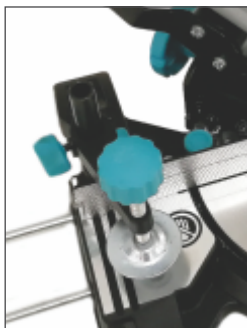

SPECIFICAȚII TEHNICE

Tensiune/Frecvență	220-240V / 50Hz
Putere	1.400 W
Diametru disc	Ø210mm
Rotații per minut	5.000 rpm
Ghidaj	Laser + Tija



1 bucată / cutie

1 bucată / bax

Cod bare: 6426910015301

FIERĂSTRĂU PENDULAR SABIE 710W 115 mm

DZ-SE102



SPECIFICAȚII TEHNICE

Tensiune/Frecvență	220-240V/50Hz
Putere	710W
Turație	2.800 rpm
Performanțe tăiere	115 mm
Lungimea cursei de tăiere	20 mm



1 bucată / cutie
6 bucăți / bax
Cod bare: 6426910015196

FIERĂSTRĂU PENDULAR 600W 80 mm

DZ-SE103



SPECIFICAȚII TEHNICE

Tensiune/Frecvență	220-240V/50Hz
Putere	600W
Turație	3.000 rpm
Performanțe tăiere	80 mm
Lungimea cursei de tăiere	18 mm



1 bucată / cutie
10 bucăți / bax
Cod bare: 6426910015202

FIERĂSTRĂU PENDULAR 450W 55 mm

DZ-SE104

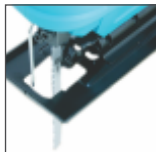

SPECIFICAȚII TEHNICE

Tensiune/Frecvență	220-240V/50Hz
Putere	450W
Turație	3.000 rpm
Performanțe tăiere	55 mm
Lungimea cursei de tăiere	17 mm



1 bucată / cutie
10 bucăți / bax
Cod bare: 6426910015219

MAȘINĂ DE TENCUIT PNEUMATICĂ

DZ-C202



SPECIFICAȚII TEHNICE

Material cuvă	Inox
Capacitate lucru/eficiență	60 m ² /oră
Presiune lucru	8-10 bar
Conexiune sistem compresie aer	3/8"



1 bucată / cutie
6 bucăți / bax
Cod bare: 6426910014090

AMESTECĂTOR VOPSEA / MORTAR • 1.300W • MIXER • 2 VITEZE

DZ-C205



Iluminare
LED



SPECIFICAȚII TEHNICE

Tensiune/Frecvență 220-240V/50Hz
Putere 1.300W
Paletă de amestecare Ø120 mm
Viteză de rotație 180-340/300-680 rpm



1 bucată / cutie
4 bucăți / bax
Cod bare: 6426910015059

AMESTECĂTOR VOPSEA / MORTAR • 1.200W • 50 cm

DZ-C207



SPECIFICAȚII TEHNICE

Tensiune/Frecvență 220-240V/50Hz
Putere 1.200W
Paletă de amestecare Ø120 mm
Viteză de rotație 240-850 rpm



1 bucată / cutie
4 bucăți / bax
Cod bare: 6426910015417

AMESTECĂTOR VOPSEA / MORTAR • 1.800W • 2 VITEZE

DZ-C220



Înălțime
reglabilă 10 cm



SPECIFICAȚII TEHNICE

Tensiune/Frecvență	220-240V/50Hz
Putere	1.800W
Paletă de amestecare	Ø120 mm
Viteză de rotație	180-430/300-680 rpm



1 bucată / cutie
4 bucăți / bax
Cod bare: 6426910019057

ȘLEFUIȚOR PENTRU PEREȚI EXTENSIBIL CU ASPIRATOR 750W Ø215 mm

DZ-C200

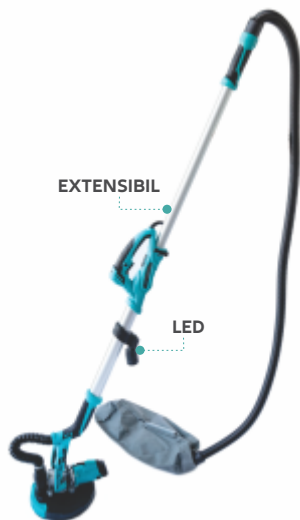

SPECIFICAȚII TEHNICE

Tensiune/Frecvență	220-240V/50Hz
Putere	750W
Diametru	Ø215 mm
Viteză de rotație	1.000-1.600 rpm
Aspirație	Aspirator și sac



1 bucată / cutie
1 bucată / bax
Cod bare: 6426910014021

ȘLEFUIȚOR PENTRU PEREȚI PLIABIL CU LED 750W Ø225 mm

DZ-C206



SPECIFICAȚII TEHNICE

Tensiune/Frecvență	220-240V/50Hz
Putere	750W
Diametru	Ø225 mm
Viteză de rotație	800-1.700 rpm
Aspirație	Aspirator și sac



1 bucată / cutie
1 bucată / bax
Cod bare: 6426910015165

ȘLEFUIȚOR PENTRU PEREȚI 750W 180 mm

DZ-C210



SPECIFICAȚII TEHNICE

Tensiune/Frecvență	220-240V/50Hz
Putere	750W
Diametru	Ø180 mm
Viteză de rotație	1.300-2.500 rpm
Aspirație	Aspirator și sac



1 bucată / cutie
4 bucăți / bax
Cod bare: 6426910015868

ȘLEFUIȚOR PENTRU PEREȚI EXTENSIBIL 750W Ø215 mm

DZ-C201



SPECIFICAȚII TEHNICE

Tensiune/Frecvență	220-240V/50Hz
Putere	750W
Diametru	Ø215 mm
Viteză de rotație	1.000-1.600 rpm
Aspirație	Aspirator



1 bucată / cutie
1 bucată / bax
Cod bare: 6426910014038

ȘLEFUIȚOR PENTRU PEREȚI EXTENSIBIL CU ASPIRATOR ȘI SAC

DZ-C218

SPECIFICAȚII TEHNICE

Tensiune/Frecvență	220-240V/50Hz
Putere	710W
Diametru	Ø225 mm
Viteză de rotație	1.000-1.700 rpm
Aspirație	Aspirator și sac



1 bucată / cutie
1 bucată / bax
Cod bare: 6426910019033



MAȘINĂ ELECTRICĂ DE ȘLEFUIT BETON UMED

DZ-C222



CONSUMABILE INCLUSE:

- 1 x disc de plastic pentru șlefuire
- 1 x disc hârtie abrazivă pentru șlefuire
- 1 x disc de burete pentru șlefuire

SPECIFICAȚII TEHNICE

Tensiune/Frecvență	220-230V/50Hz
Putere	750W
Diametru	Ø410 mm
Viteză de rotație	100 rpm



1 bucată / cutie
2 bucăți / bax
Cod bare: 6426910019071

MAȘINĂ CANELURI PENTRU RIGIPS ȘI ZIDĂRIE MOALE

DZ-C219

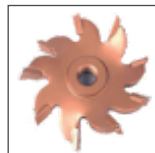

ACCESORII INCLUSE:

- Disc tăiere, cheie eliberare, cheie hexagonală, perie carbon, cutie plastic BMC

SPECIFICAȚII TEHNICE

Tensiune/Frecvență	220-230V/50Hz
Putere	1.100W
Adâncime canelură tăiată	30-40 mm
Lățime canelură tăiată	30-40 mm
Viteză de rotație	1.600 rpm



1 bucată / cutie
2 bucăți / bax
Cod bare: 6426910019040

MAȘINĂ CANELURI ȘI CĂNTUIRE PLĂCI CERAMICE ȘI BETON

DZ-C221



Pompă apă pentru răcire
cu priză cu protecție
la suprasarcină și fuzibilă



ACCESORII INCLUSE:

5x disc, 2x perie carbon, cheie, cheie hexagonală, cutie transport BMC

SPECIFICAȚII TEHNICE

Tensiune/Frecvență	220-230V/50Hz
Putere	3.200W
Adâncime canelură tăiată	42 mm
Lățime canelură tăiată	40 mm
Viteză de rotație	6.500 rpm



1 bucată / cutie

1 bucată / box

Cod bare: 6426910019064



MAȘINĂ DE ÎNȘURUBAT CU ACUMULATOR 12V Li-ion

DZ-SE109



Iluminare
LED



SPECIFICAȚII TEHNICE

Tensiune acumulator	12V
Capacitate acumulator	Li-Ion 1,3Ah
Viteză de rotație	1.300 rpm
Număr acumulatori	2
Moment	25 Nm



1 bucată / cutie
10 bucăți / bax
Cod bare: 6426910015509

MAȘINĂ DE ÎNȘURUBAT CU ACUMULATOR 14,4V Li-ion

DZ-SE110



Iluminare
LED



SPECIFICAȚII TEHNICE

Tensiune acumulator	14,4V
Capacitate acumulator	Li-Ion 1,3Ah
Viteză de rotație	1.550 rpm
Număr acumulatori	2
Moment	28 Nm



1 bucată / cutie
5 bucăți / bax
Cod bare: 6426910015516

MAȘINĂ DE ÎNȘURUBAT CU ACUMULATOR 18V Li-ion

DZ-SE111



Illuminare
LED



SPECIFICAȚII TEHNICE

Tensiune acumulator	18V
Capacitate acumulator	Li-Ion 1,3Ah
Viteză de rotație	1.550 rpm
Număr acumulatori	2
Moment	30 Nm



1 bucată / cutie
5 bucăți / bax
Cod bare: 6426910015523

MAȘINĂ DE ÎNȘURUBAT ȘI GĂURIT CU PERCUȚIE CU 2 ACUMULATORI Li-Ion 18V

DZ-SE127



Illuminare
LED



SPECIFICAȚII TEHNICE

Tensiune acumulator	18V
Capacitate acumulator	Li-Ion 1,3Ah
Viteză de rotație	1.450 rpm
Percuție/Impact	0-4.800 bpm
Număr acumulatori	2
Moment	63 Nm



1 bucată / cutie
6 bucăți / bax
Cod bare: 6426910016896

MAȘINĂ DE GĂURIT ȘI ÎNȘURUBAT CU 2 ACUMULATORI Li-Ion 18V

DZ-SE128

SPECIFICAȚII TEHNICE

Tensiune acumulator	18V
Capacitate acumulator	Li-Ion 1,3Ah
Viteză de rotație	1.450 rpm
Număr acumulatori	2
Moment	63 Nm

Illuminare
LED



1 bucată / cutie
6 bucăți / bax
Cod bare: 6426910016889



MAȘINĂ DE GĂURIT ȘI ÎNȘURUBAT CU IMPACT CU ACUMULATORI Li-Ion 20V/4Ah

DZ-SE129

SPECIFICAȚII TEHNICE

Tensiune acumulator	20V
Capacitate acumulator	Li-Ion 4Ah
Tip acumulator	Fast charger
Viteză de rotație	Treapta 1: 0-1.600 rpm Treapta 2: 0-2.100 rpm Treapta 3: 0-2.400 rpm
Percuție/Impact	Treapta 1: 0-2.600 bpm Treapta 2: 0-3.100 bpm Treapta 3: 0-3.600 bpm
Număr acumulatori	2
Moment	450 Nm



1 bucată / cutie
5 bucăți / box
Cod bare: 6426910019293



MAȘINĂ DE GĂURIT ȘI ÎNȘURUBAT CU PERCUȚIE CU ACUMULATORI Li-Ion 20V

DZ-SE134

SPECIFICAȚII TEHNICE

Tensiune acumulator	20V
Capacitate acumulator	Li-Ion 4Ah
Tip acumulator	Fast Charger
Viteză de rotație	Treapta 1: 0-450 rpm Treapta 2: 0-1.600 rpm
Percuție/Impact	0-2.250 bpm
Moment	55-60 Nm
Setări moment	19+1



1 bucată / cutie
5 bucăți / box
Cod bare: 6426910020336

Mâner lateral
din aluminiu

Mandrina fără cheie
din metal de 13 mm
(cu sistem de blocare)



MAȘINĂ DE GĂURIT ȘI ÎNȘURUBAT CU BANDĂ CU ȂCUMULATOR Li-Ion 20V/4Ah

DZ-SE137



ACCESORII INCLUSE:

- Bit IPC
- Lanț cu șuruburi (șuruburi: 50 buc)

SPECIFICAȚII TEHNICE

Tensiune acumulator	20V
Capacitate acumulator	Li-Ion 4Ah
Tip acumulator	Fast Charger
Viteză de rotație	Treapta 1: 0-400 rpm Treapta 2: 0-1.450 rpm
Diametru/lungime șuruburi	6/25-45 mm
Moment	29 Nm
Setări moment	18+1



1 bucată / cutie
5 bucăți / bax
Cod bare: 6426910020367

CIOCAN ROTOPERCUTOR CU ACUMULATOR Li-Ion 20V/4Ah

DZ-SE133

SPECIFICAȚII TEHNICE

Tensiune acumulator	20V
Capacitate acumulator	Li-Ion 4Ah
Tip acumulator	Fast charger
Viteză de rotație	0-1.100 rpm
Percuție/Impact	0-4.400 bpm
Putere de impact	2,2J

CAPACITATE GĂURIRE	Beton	Ø22 mm
	Metal	Ø13 mm
	Lemn	Ø30 mm



1 bucată / cutie
5 bucăți / box
Cod bare: 6426910020329



Motor fără perii
(BRUSHLESS)

FIERĂSTRĂU PENDULAR SABIE CU ACUMULATOR Li-Ion 20V/4Ah

DZ-SE135

SPECIFICAȚII TEHNICE

Tensiune acumulator	20V
Capacitate acumulator	Li-Ion 4Ah
Tip acumulator	Fast Charger
Viteză de rotație	0-2.800 rpm
Lungime cursă	22 mm
Capacitate tăiere lemn	100 mm

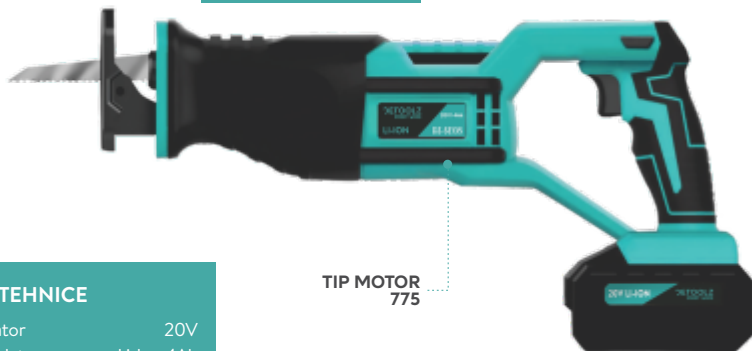

TIP MOTOR
775



1 bucată / cutie
4 bucăți / box
Cod bare: 6426910020343

POLIZOR UNGHIULAR CU ACUMULATOR Li-Ion 20V/4Ah

DZ-SE132



Motor 5030# fără perii
(BRUSHLESS)



1 bucată / cutie
4 bucăți / bax
Cod bare: 6426910020312

SPECIFICAȚII TEHNICE

Tensiune acumulator	20V
Capacitate acumulator	Li-Ion 4Ah
Tip acumulator	Fast charger
Viteză de rotație	0-4.500 / 5.500 / 7.000 rpm
Diametru disc	125 mm



MAȘINĂ DE GĂURIT CU PERCUȚIE 600W (BORMAȘINĂ)

DZ-SE115



SPECIFICAȚII TEHNICE

Tensiune / Frecvență 220-240V/50Hz
Putere 600W
Viteză de rotație 2.800 rpm

CAPACITATE GĂURIRE	Beton	Ø16 mm
	Metal	Ø13 mm
	Lemn	Ø25 mm



1 bucată / cutie
10 bucăți / bax
Cod bare: 6426910016148

MAȘINĂ DE GĂURIT CU PERCUȚIE 810W (BORMAȘINĂ)

DZ-SE116



SPECIFICAȚII TEHNICE

Tensiune / Frecvență 220-240V/50Hz
Putere 810W
Viteză de rotație 2.800 rpm

CAPACITATE GĂURIRE	Beton	Ø16 mm
	Metal	Ø13 mm
	Lemn	Ø25 mm



1 bucată / cutie
10 bucăți / bax
Cod bare: 6426910016155

MAȘINĂ DE GĂURIT CU PERCUȚIE 910W (BORMAȘINĂ)

DZ-SE117



SPECIFICAȚII TEHNICE

Tensiune / Frecvență 220-240V/50Hz
Putere 910W
Viteză de rotație 2.800 rpm

CAPACITATE GĂURIRE	Beton	Ø16 mm
	Metal	Ø13 mm
	Lemn	Ø25 mm



1 bucată / cutie
10 bucăți / bax
Cod bare: 6426910016162

CIOCAN ROTOPERCUTOR 600W

DZ-SE130



SPECIFICAȚII TEHNICE

Tensiune / Frecvență	220-240V/50Hz
Putere	600 W
Viteză de rotație	0-870 rpm
Percuție / Impact	0-4.800 bpm
Energie	2,2J

CAPACITATE GĂURIRE	Beton	Ø22 mm
	Metal	Ø13 mm
	Lemn	Ø30 mm



1 bucată / cutie
5 bucăți / bax
Cod bare: 6426910019309

CIOCAN ROTOPERCUTOR 800W

DZ-SE131



SPECIFICAȚII TEHNICE

Tensiune / Frecvență	220-240V/50Hz
Putere	800 W
Viteză de rotație	0-1.100 rpm
Percuție / Impact	0-4.000 bpm
Energie	3,0J

CAPACITATE GĂURIRE	Beton	Ø22 mm
	Metal	Ø13 mm
	Lemn	Ø30 mm



1 bucată / cutie
5 bucăți / bax
Cod bare: 6426910019316

CIOCAN ROTOPERCUTOR 1.500W

DZ-SE118



SPECIFICAȚII TEHNICE

Tensiune / Frecvență	220-240V/50Hz
Putere	1.500 W
Viteză de rotație	0-800 rpm
Percuție / Impact	0-4.000 bpm
Energie	3,0J

CAPACITATE GĂURIRE	Beton	Ø26 mm
	Metal	Ø13 mm
	Lemn	Ø40 mm



1 bucată / cutie
4 bucăți / bax
Cod bare: 6426910016179

POLIZOR UNGHIULAR 800W 125 mm DZ

DZ-SE105



SPECIFICAȚII TEHNICE

Tensiune/Frecvență	220-230V/50Hz
Putere	800W
Viteză de rotație	12.000 rpm
Diametru disc	125 mm



1 bucată / cutie
6 bucăți / bax
Cod bare: 6426910015295

POLIZOR UNGHIULAR 600W 115 mm DZ

DZ-SE112



SPECIFICAȚII TEHNICE

Tensiune/Frecvență	220-230V/50Hz
Putere	600W
Viteză de rotație	12.000 rpm
Diametru disc	115 mm



1 bucată / cutie
6 bucăți / bax
Cod bare: 6426910016117

POLIZOR UNGHIULAR 750W 125 mm DZ

DZ-SE113



SPECIFICAȚII TEHNICE

Tensiune/Frecvență	220-230V/50Hz
Putere	750W
Viteză de rotație	12.000 rpm
Diametru disc	125 mm



1 bucată / cutie
6 bucăți / bax
Cod bare: 6426910016124

POLIZOR UNGHIULAR 1.200W 125 mm CU MÂNER LUNG DZ

DZ-SE114



SPECIFICAȚII TEHNICE

Tensiune/Frecvență	220-230V/50Hz
Putere	1.200W
Viteză de rotație	12.000 rpm
Diametru disc	125 mm



1 bucată / cutie
6 bucăți / bax
Cod bare: 6426910016131

TELEMETRU CU LASER MS-40a

DZ-C203



SPECIFICAȚII TEHNICE

Distanță măsurare	0,05-40 m
Protecție	IP54
Memorie	20 măsurători
Durată baterie	5.000 măsurători
Viață buton măsurare	peste 1 milion
Precizie	+/- 1,5 mm



1 bucată / cutie
72 bucăți / bax
Cod bare: 6426910014212

TELEMETRU CU LASER MS-60a

DZ-C204



SPECIFICAȚII TEHNICE

Distanță măsurare	0,05-60 m
Protecție	IP54
Memorie	20 măsurători
Durată baterie	5.000 măsurători
Viață buton măsurare	peste 1 milion
Precizie	+/- 1,5 mm



1 bucată / cutie
72 bucăți / bax
Cod bare: 6426910014229

MAȘINĂ DE TĂIAT PLĂCI CERAMICE 400 mm

DZ-C211

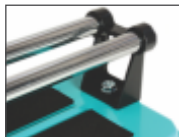
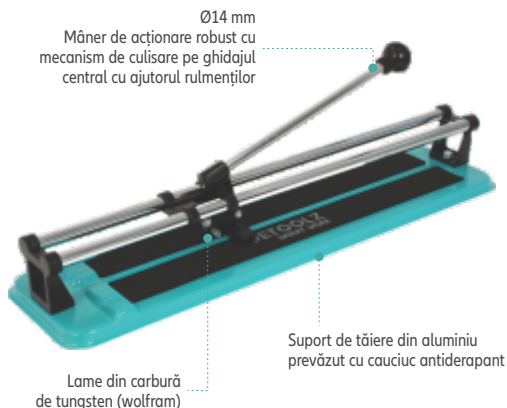

SPECIFICAȚII TEHNICE

Grosime taiere	10 mm
Lungime taiere	400 mm
Grosime metal	1,7 mm
Regim utilizare	Hobby



1 bucată / cutie
10 bucăți / bax
Cod bare: 6426910015936

MAȘINĂ DE TĂIAT PLĂCI CERAMICE 600 mm

DZ-C212

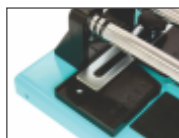
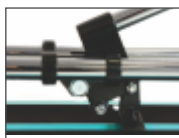
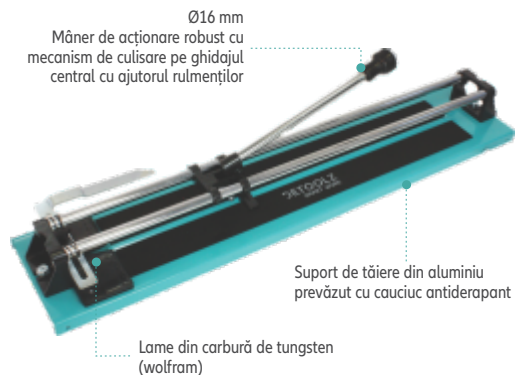

SPECIFICAȚII TEHNICE

Grosime taiere	12 mm
Lungime taiere	600 mm
Grosime metal	1,8 mm
Regim utilizare	Hobby



1 bucată / cutie
4 bucăți / bax
Cod bare: 6426910015943

MAȘINĂ PROFESIONALĂ DE TĂIAT PLĂCI CERAMICE 600 mm

DZ-C213

Ø16 mm
Mâner de acționare robust cu
mecanism de culisare pe ghidajul
central cu ajutorul rulmenților



Lame din carbură
de tungsten (wolfram)

Suport de tăiere
cu ansamblu rulmenți cu bile



SPECIFICAȚII TEHNICE

Grosime tăiere	14 mm
Lungime tăiere	600 mm
Grosime metal	2,5 mm
Regim utilizare	Profesional



1 bucată / cutie
2 bucăți / bax
Cod bare: 6426910015950

MAȘINĂ PROFESIONALĂ DE TĂIAT PLĂCI CERAMICE 800 mm

DZ-C214

Mâner ergonomic de
acționare din cauciuc

- Role tăietoare integrate cu rulmenți;
- Lame de tăiere compatibile:
YG6X, 22x6x6 mm

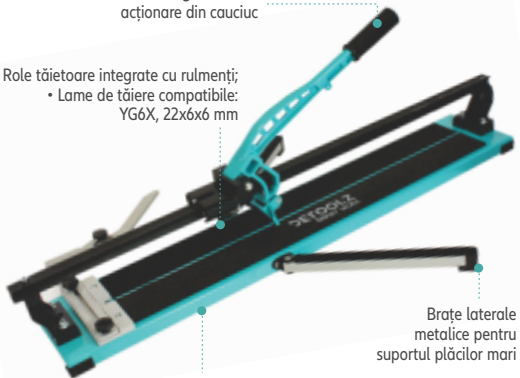

Brațe laterale
metalice pentru
suportul plăcilor mari

Bază din oțel prevăzută cu cauciuc
antiderapant care asigură protecție
împotriva deteriorării plăcilor



SPECIFICAȚII TEHNICE

Grosime tăiere	16 mm
Lungime tăiere	800 mm
Grosime metal	2,5 mm
Regim utilizare	Profesional



1 bucată / cutie
2 bucăți / bax
Cod bare: 6426910015967

MAȘINĂ PROFESIONALĂ DE TĂIAT PLĂCI CERAMICE 1.000 mm

DZ-C215

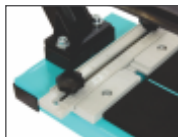
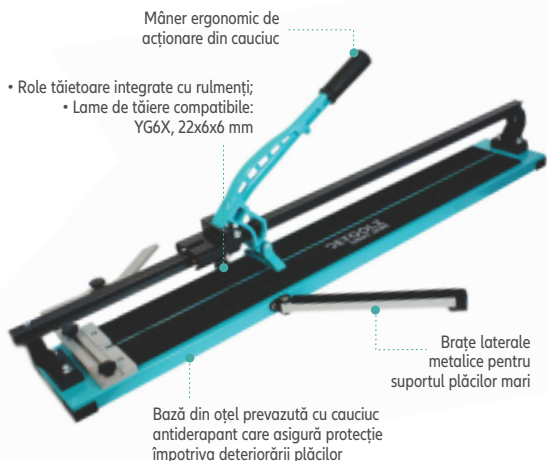

SPECIFICAȚII TEHNICE

Grosime taiere	16 mm
Lungime taiere	1.000 mm
Grosime metal	2,5 mm
Regim utilizare	Profesional



1 bucată / cutie
2 bucăți / bax
Cod bare: 6426910015974

MAȘINĂ PROFESIONALĂ DE TĂIAT PLĂCI CERAMICE 1.200 mm

DZ-C217

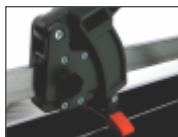
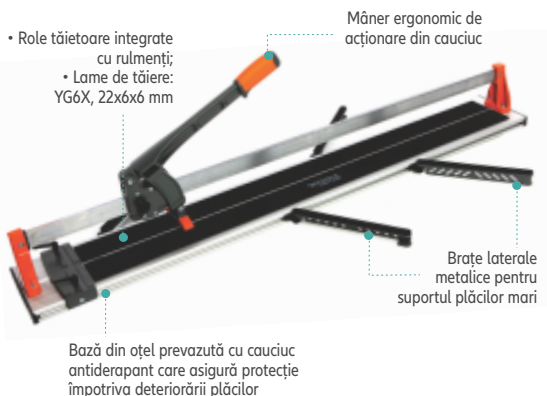

SPECIFICAȚII TEHNICE

Grosime taiere	16 mm
Lungime taiere	1.200 mm
Grosime metal	2,5 mm
Regim utilizare	Profesional



1 bucată / cutie
1 bucată / bax
Cod bare: 6426910018371

GHIOLINĂ PENTRU TĂIAT PARCHET LAMINAT 10x210 mm

DZ-C216

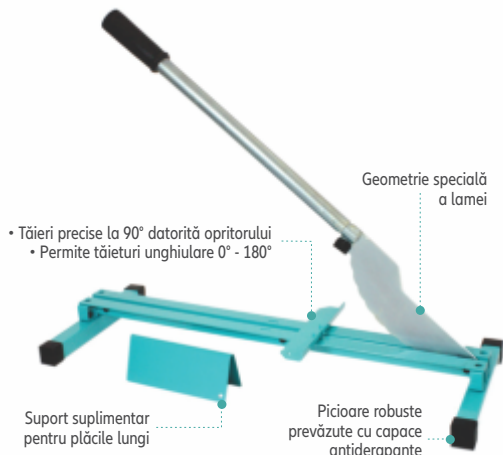

SPECIFICAȚII TEHNICE

Grosime taiere	12 mm
Lungime taiere	210 mm
Regim utilizare	Profesional



1 bucată / cutie
1 bucată / bax
Cod bare: 6426910015981

CLEȘTE FIERAR BETONIST 300 mm

DZ-C209



6 bucăți / pungă
36 bucăți / bax
Cod bare: 6426910015554

CIOCAN 1 CIOC VERDE MAGNETIC

DZ-C208



6 bucăți / pungă
36 bucăți / bax
Cod bare: 6426910015547

DETOOLZ

SMART WORK

Informațiile cuprinse în aceasta broșură au un caracter general de prezentare și pot conține erori datorate procesării sau unor modificări ulterioare ale producătorilor. Pozele pot să nu reflecte forma sau culoarea finală a produsului. Toate produsele respectă reglementările CE în vigoare și sunt disponibile prin rețeaua de distribuție GOLDEN FISH SRL.

DETOOLZ

SMART WORK

(+4) 0746 533 474

contact@micul-fermier.ro

www.micul-fermier.ro

SC GOLDEN FISH SRL

Comuna Ștefăneștii de Jos, Șoseaua de Centură nr. 6,
Platforma betonată D.1.1., Pavilion Administrativ,
Biroul nr.12, Etaj 1, Județul Ilfov